



NAWT

National Association of **Wastewater** Technicians

Mastering Vacuum and Pressure Techniques! Putting all Together

By Jeff Rachlin and Mike Chouinard



Presented at the 2025 NOWRA Mega-Conference, October 19-22, 2025



What have we learned?

- Pressure is always trying to equalize itself
- 1" of Hg = 1' of water column
- Force = Area x Pressure
- Friction works against us
- How Hose Diameter Affects us
- How Hose Length Affects us
- How Weight of Material Affects us









What have we learned?

- How Weight of Material Affects us
- How Viscosity Affects us
- How Geographic Elevation Affects us
- How Atmospheric Pressure Affects us



Air Compression and Expansion

Boyles law
(Volume and Pressure Changes) at Depth

Depth	Pressure	Relative Volume	Volume
Sea level	1 ATA	1 or 100%	20 l 
10 M	2 ATA	1/2 or 50%	10 l 
20 M	3 ATA	1/3 or 33 %	6.7 l 
30 M	4 ATA	1/4 or 25 %	5 l 
40 M	5 ATA	1/5 or 20%	4 l 
90 M	10 ATA	1/10 or 10%	2 l 



NB: Change in volume with pressure is the greatest nearer the surface



Air Expansion Chart (NVE)

VACUUM INCHES OF MERCURY GAUGE

AIR VOLUME EXPANSION RATIO

30	Infinite
29.8	150
29.5	60
29	30
28.5	20
28	15
27.5	12
27	10
25	6
22	3.75
20	3
15	2
10	1.5
5	1.2
0	1





Filtration

- This Room is a giant filter
- The Tank on the truck is a filter
- Air Movement and Weight can be a filter
- A Cyclone is a filter



Cyclone Demo



Solid Column Lifting VS Air Conveyance



- We know that product is being pushed into your truck
- The height of push is relative to the amount of Vacuum
- 27" of Hg is equal to about 27' of water column



We know that

Water weighs 62.4 pounds per cubic foot

Does it still weigh 62.4 pounds per cubic foot

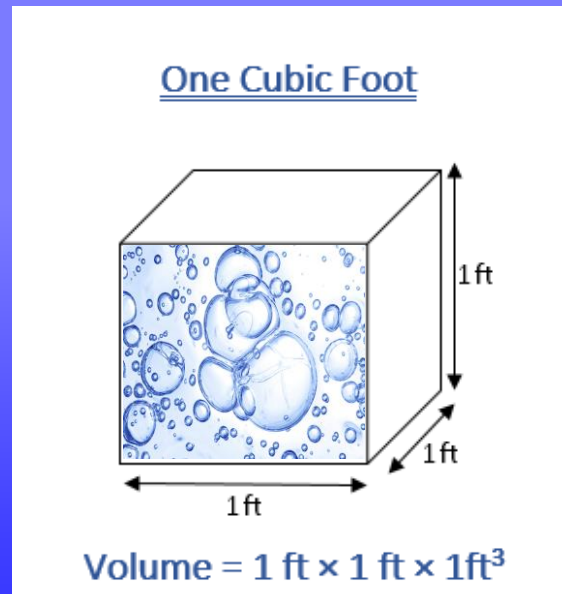

How can we add air to product?





How not to make a Stinger

My brother got very lucky today. Only got 1 little stitch in his arm. Learned my lesson here, never using a piece of pvc to pump again, let alone a 45 degree angled piece. Damn beer bottle got stuck at the elbow and busted through. Be safe out there, fellow pumpers.



Snorkel Air Injection

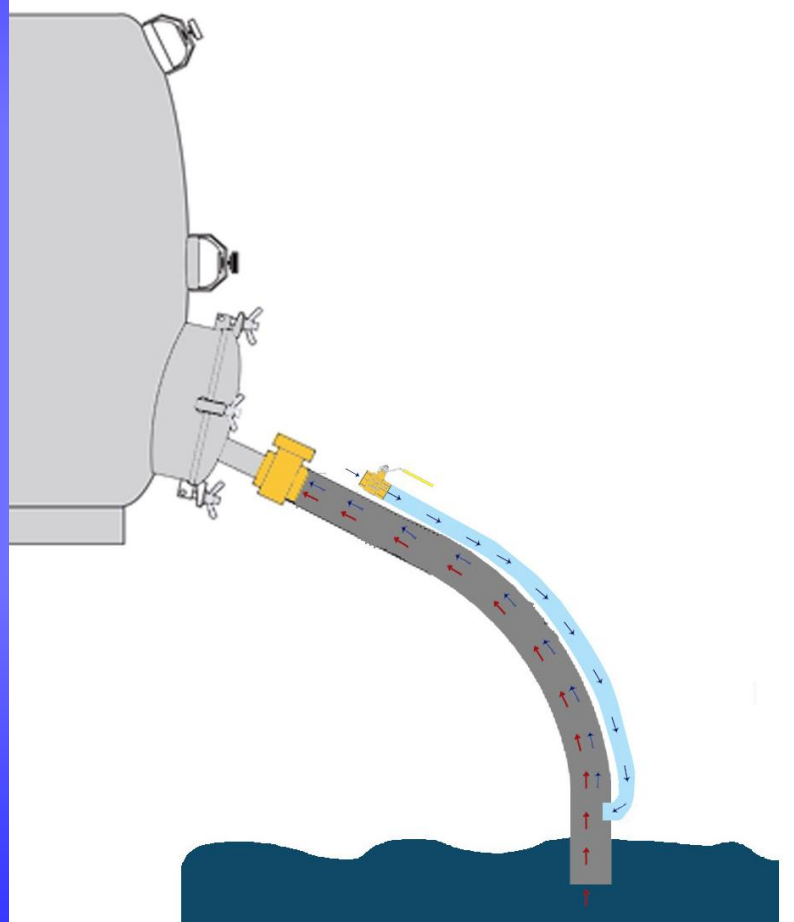

Different Types of Pumps

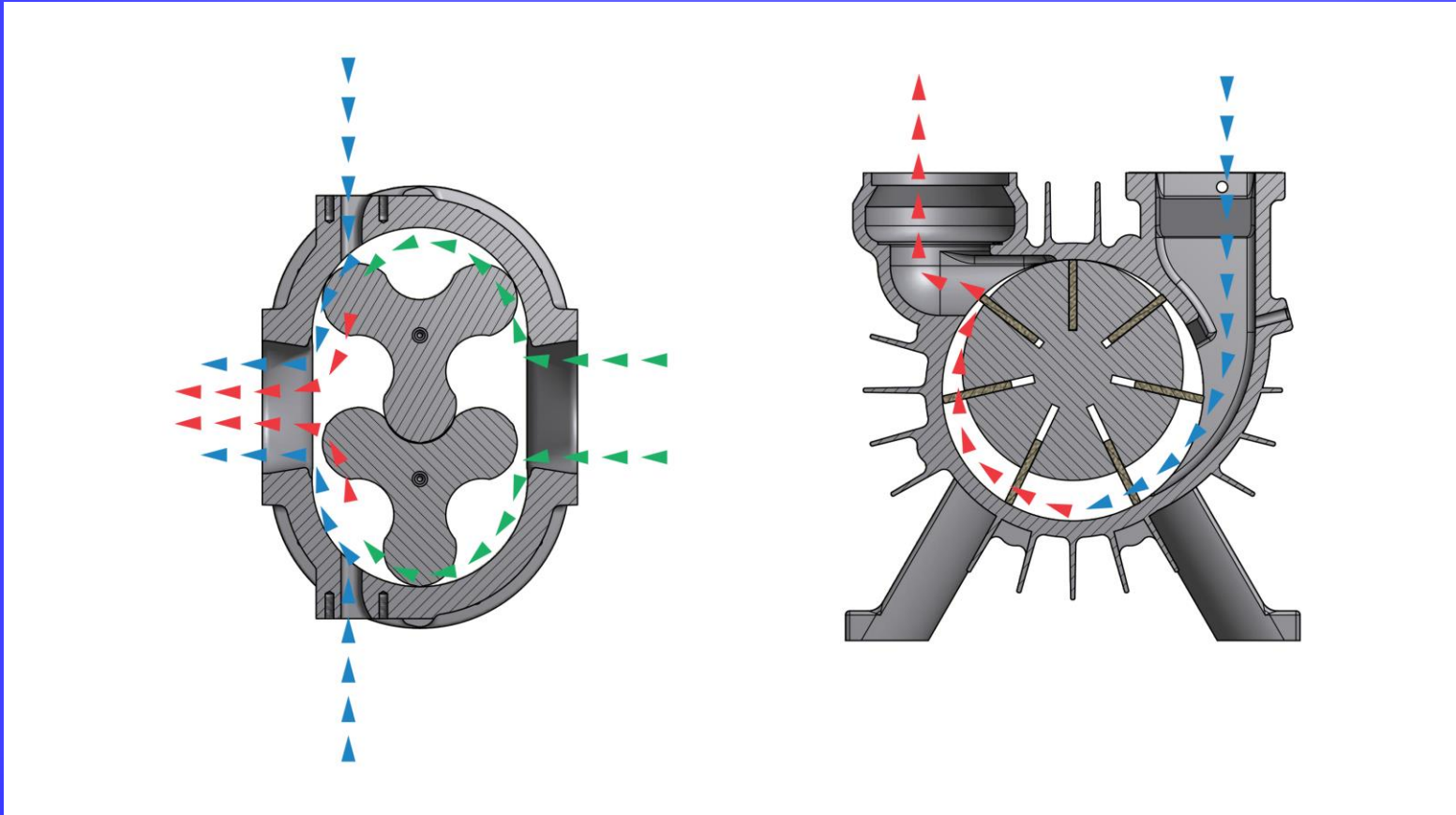



**Thank
You!**



